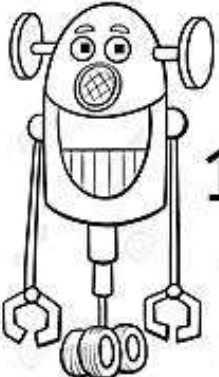
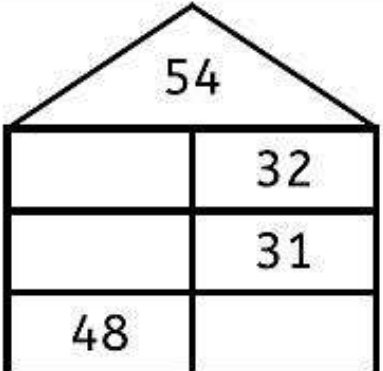
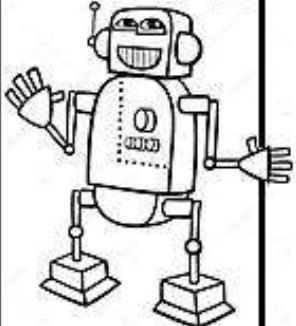
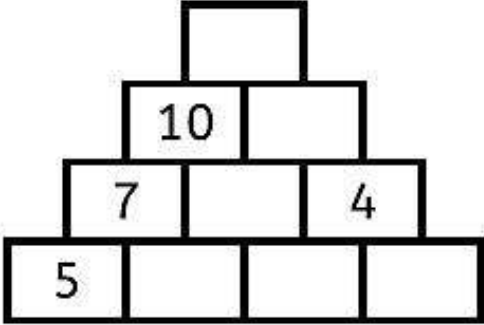
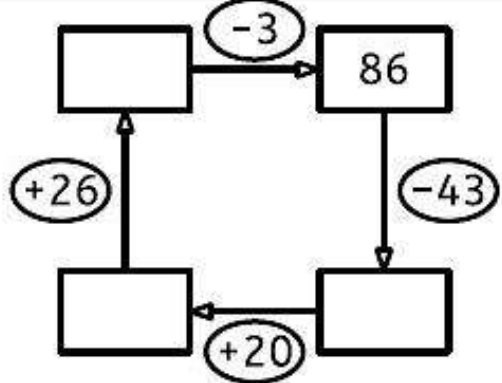
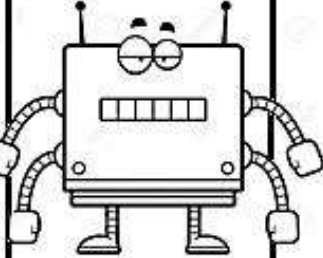
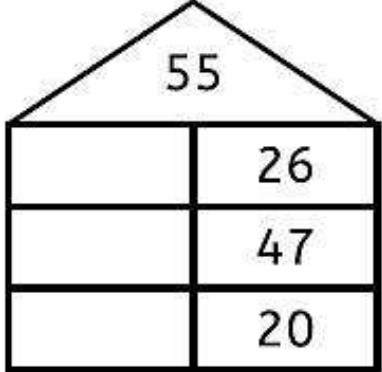
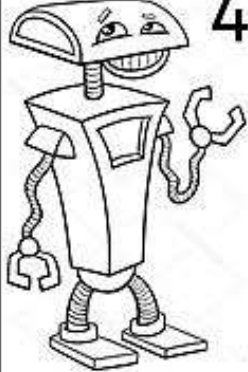
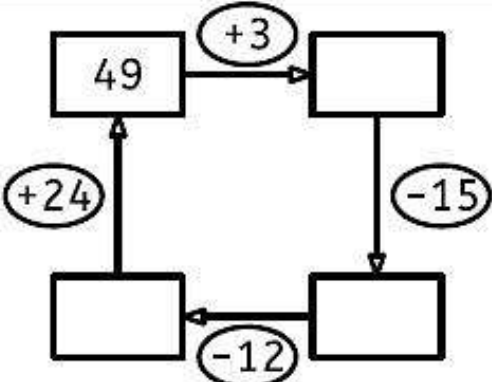
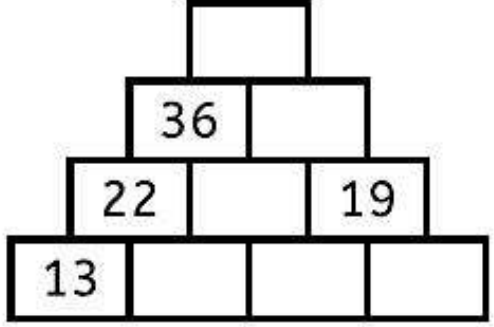

Nombre: ..... Fecha: .....

# CÁLCULO MENTAL HASTA 100

 <p>1</p>		$13 + 25 = \underline{\quad}$ $42 - 24 = \underline{\quad}$ $9 + 10 = \underline{\quad}$ $22 - 18 = \underline{\quad}$
 <p>2</p>		
 <p>3</p>	$\underline{\quad} - 12 = 2$ $\underline{\quad} + 50 = 67$ $\underline{\quad} + 26 = 57$ $\underline{\quad} - 13 = 16$	
 <p>4</p>		

# SOLUCIONES:

1

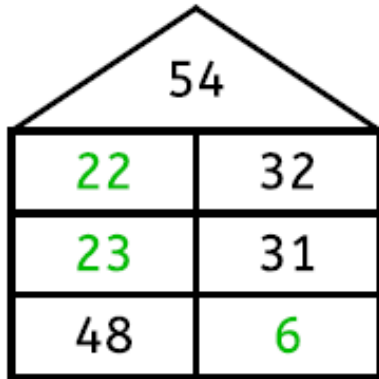

$$13 + 25 = \underline{38}$$

$$42 - 24 = \underline{18}$$

$$9 + 10 = \underline{19}$$

$$22 - 18 = \underline{4}$$

2

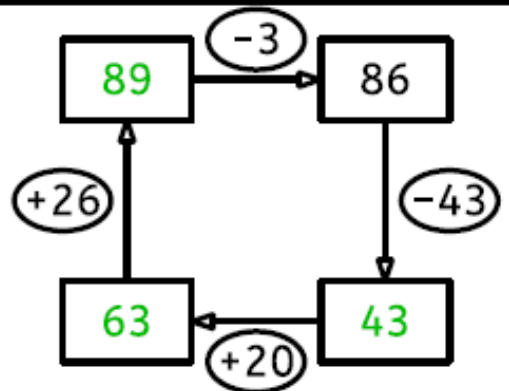
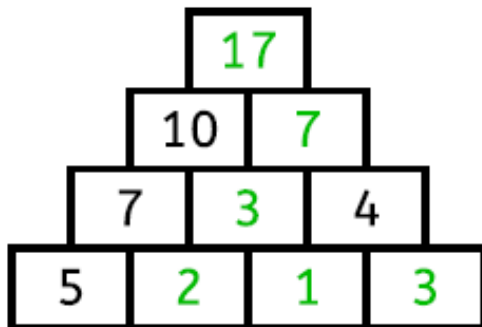

3

$$\underline{14} - 12 = 2$$

$$\underline{17} + 50 = 67$$

$$\underline{31} + 26 = 57$$

$$\underline{29} - 13 = 16$$

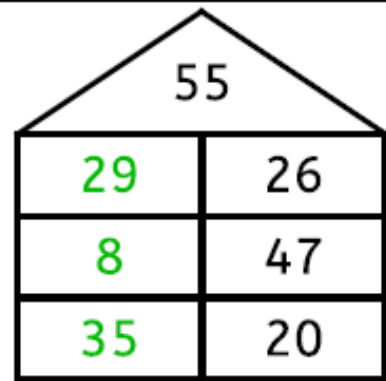

4

