

Palmea cada palabra y copia sus sílabas. ¿Cuántas tiene?

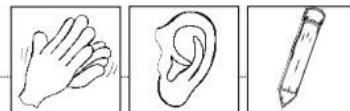

Ficha 2



NOMBRE:

tijeras 3

libro

lápiz

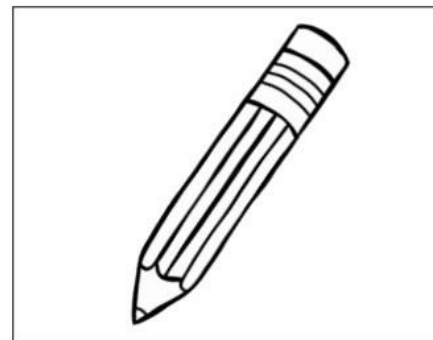
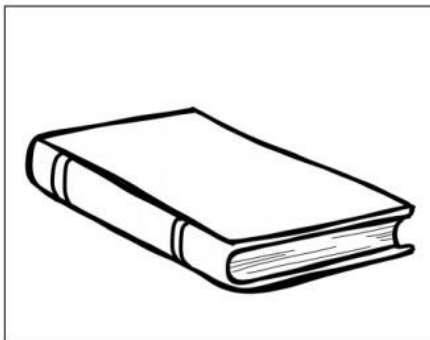
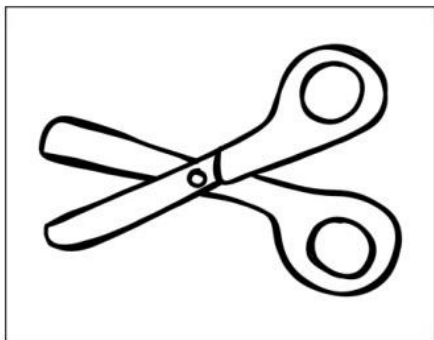

ti - je - ras - - - - - - -

sacapuntas

cola

manzana

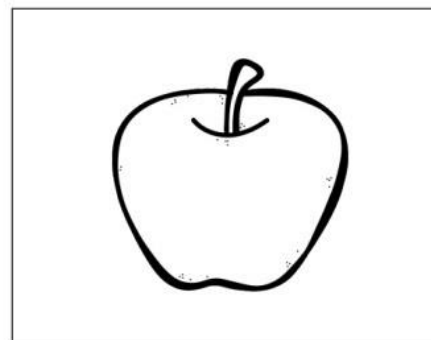
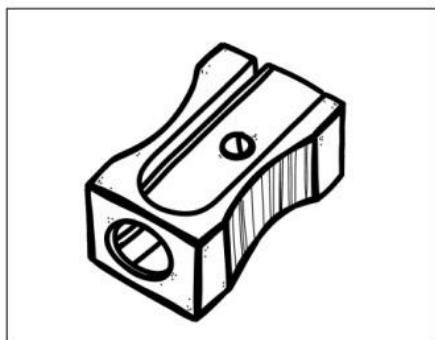

- - - - - - - - -

pincel

mochila

botella

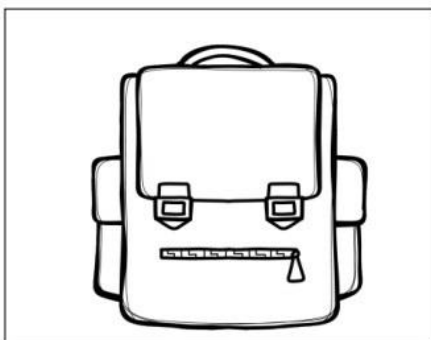
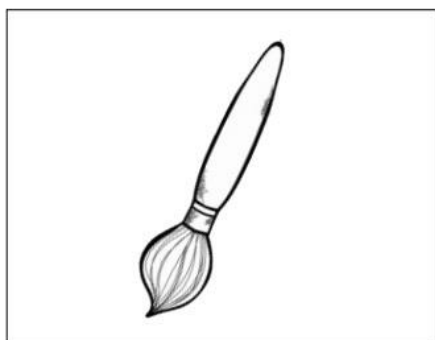

- - - - - - - - -